



#F2402 & F2602 Installation Instructions 2004-2008 Ford F-150 4wd 4-6" Lift System

Read and understand all instructions and warnings prior to installation of product and operation of vehicle.

Zone Offroad Products recommends this system be installed by a professional technician. In addition to these instructions, professional knowledge of disassembly/ reassembly procedures and post installation checks must be known. Minimum tool requirements include the following: Assorted metric and standard wrenches, hammer, hydraulic floor jack and a set of jack stands. See the "Special Tools Required" section for additional tools needed to complete this installation properly and safely.

» PRODUCT SAFETY WARNING

Certain Zone Suspension Products are intended to improve off-road performance. Modifying your vehicle for off-road use may result in the vehicle handling differently than a factory equipped vehicle. Extreme care must be used to prevent loss of control or vehicle rollover. Failure to drive your modified vehicle safely may result in serious injury or death. Zone Offroad Products does not recommend the combined use of suspension lifts, body lifts, or other lifting devices.

You should never operate your modified vehicle under the influence of alcohol or drugs. Always drive your modified vehicle at reduced speeds to ensure your ability to control your vehicle under all driving conditions. Always wear your seat belt.

» TECHNICAL SUPPORT

Live Chat provides instant communication with Zone tech support. Anyone can access live chat through a link on www.zoneoffroad.com.

www.zoneoffroad.com may have additional information about this product including the latest instructions, videos, photos, etc.

Send an e-mail to tech-zone@sporttruckusainc.com detailing your issue for a quick response.

888.998.ZONE Call to speak directly with Zone tech support.

» PRE-INSTALLATION NOTES

1. Special literature required: OE Service Manual for model/year of vehicle. Refer to manual for proper disassembly/reassembly procedures of OE and related components.
2. Adhere to recommendations when replacement fasteners, retainers and keepers are called out in the OE manual.
3. Larger rim and tire combinations may increase leverage on suspension, steering, and related components. When selecting combinations larger than OE, consider the additional stress you could be inducing on the OE and related components.
4. Post suspension system vehicles may experience drive line vibrations. Angles may require tuning, slider on shaft may require replacement, shafts may need to be lengthened or trued, and U-joints may need to be replaced.
5. Secure and properly block vehicle prior to installation of Zone Offroad Products. Always wear safety glasses when using power tools.
6. If installation is to be performed without a hoist, Zone Offroad Products recommends rear alterations first.
7. Due to payload options and initial ride height variances, the amount of lift is a base figure. Final ride height dimensions may vary in accordance to original vehicle attitude. Always measure the attitude prior to beginning installation.

Difficulty Level

easy 1 2 3 **4** 5 difficult

Estimated installation: 8-10 hours

Tire/Wheel Fitment

4" and 6" lifts*

35 x 12.50 x 17
with 4-1/2" Backspacing

35 x 12.50 x 18
with 4-1/2" to 5" Backspacing

35 x 12.50 x 20
with 4-1/2" to 5-1/2" Backspacing

***4" lifts may require minor
fender trimming**

Kit Contents

***Important* Verify you have all of the kit components before beginning installation.**

Qty	Part		
		2	Sway Bar Drop Brackets
1	Knuckle (drv)	4	18mm Cam Bolt
1	Knuckle (pass)	2	18mm x 150mm bolt
2	6" Strut Spacer	8	Cam Washer
1	Front Crossmember	6	3/4 Washer
1	Rear Crossmember	6	18mm Torque Nut
1	Differential Skid Plate	15"	5/16" hose (15in long)
1	Emergency Brake Bracket	1	Rear Brakeline Drop
1	Differential Support Brace	1	Front Brakeline -DS
1	Differential Nut Tab	1	Front Brakeline -PS
1	Differential Drop Bracket (DRV)	4	3/8" Brass Crush Washer
1	Differential Drop Bracket (PASS)	2	Brake Line Retaining Clip
1	Bolt Pack - upper strut spacer	6	zip ties
1	Bolt pack - Sway bar / Misc.		
1	Bolt pack - Differential / Skid Plate Hardware		



Wheel Notes

1. Stock 17" rims cannot be reinstalled after the lift is completed. 17" wheels require 4-1/2" of backspacing.
2. Stock 20" wheels with stock tires can be reinstalled after the lift. Larger tires cannot be put on the factory 20" wheels. 20" wheels with 4-1/2" to 5-1/2" backspacing can be used.

INSTALLATION INSTRUCTIONS

» FRONT INSTALLATION

3. Park the vehicle on a clean, flat surface and block the rear wheels for safety.
4. Measure from the center of the wheel up to the bottom edge of the wheel opening and record:
5. Raise the front of the vehicle and support with jack stands at each frame rail behind the lower control arms.
6. Remove the front wheels.
7. Remove the factory skid plate (if equipped). **Figure 1**

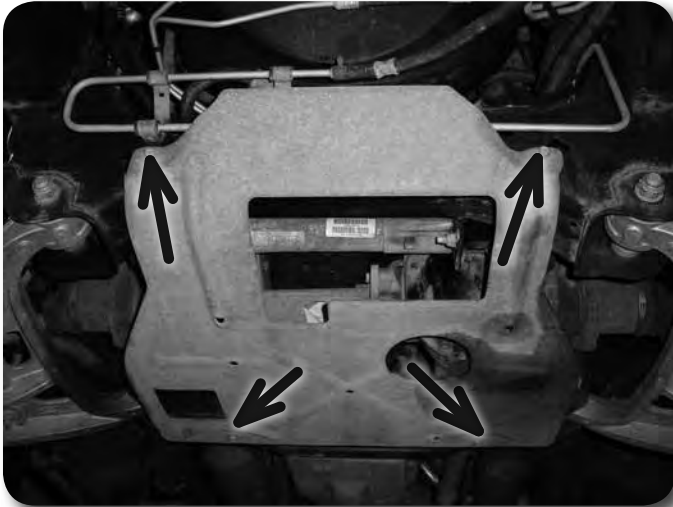

Figure 1

8. Remove the brake caliper anchor bracket bolts and remove the caliper from the knuckle **Figure 2**. Hang the caliper out of the way. Do not let the caliper hang by the brake hoses.

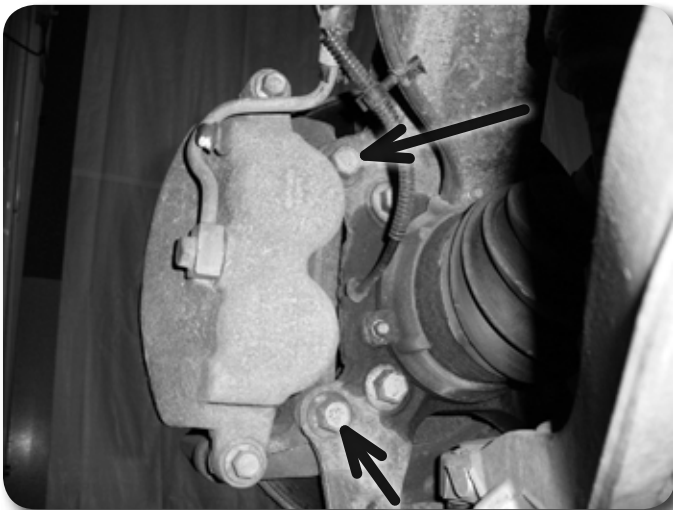

Figure 2

9. Remove the brake rotor and set aside.
10. Disconnect the ABS and hub vacuum lines from the retaining clips **Figure 3**.

Important—measure before starting!

Measure from the center of the wheel up to the bottom edge of the wheel opening

LF _____ RF _____

LR _____ RR _____



Figure 3

11. Disconnect the hub vacuum line from the hub Figure 4.

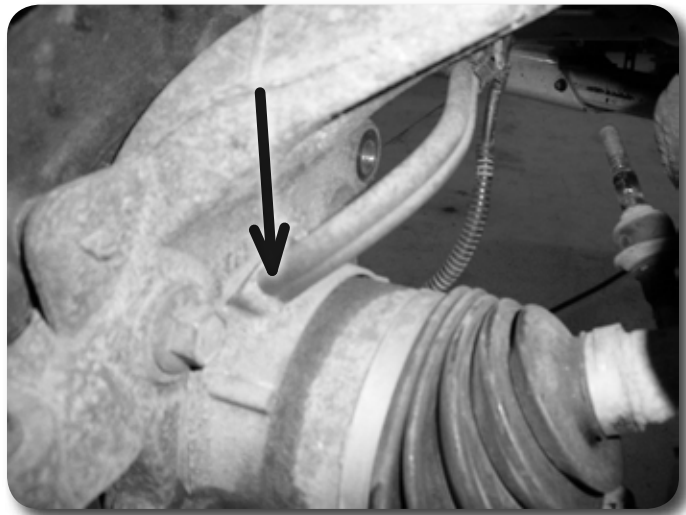

Figure 4

12. Disconnect the ABS line from the inner fender and disconnect ABS wire connector Figure 5.



Figure 5

13. Disconnect the tie rod ends from the steering knuckles **Figure 6**. Remove and retain the mounting nuts. Strike the steering knuckle near the tie rod end to dislodge the end. Take care not to strike the tie rod end.



Figure 6

14. Disconnect the sway bar links from the sway bar **Figure 7**. Retain hardware. The sway bar links do not need to be removed from the lower control arms.



Figure 7

15. Remove the four sway bar mounting nuts and remove the sway bar from the vehicle **Figure 8**. Retain hardware.

Note

Different models have different styles. The links will either have a stem or ball joint style mount at the sway bar (stem style shown)



Figure 8

16. Carefully remove the hub dust cap to expose the axle shaft nut **Figure 9**. Remove the nut. Keep the cap and nut, they will be reinstalled later.

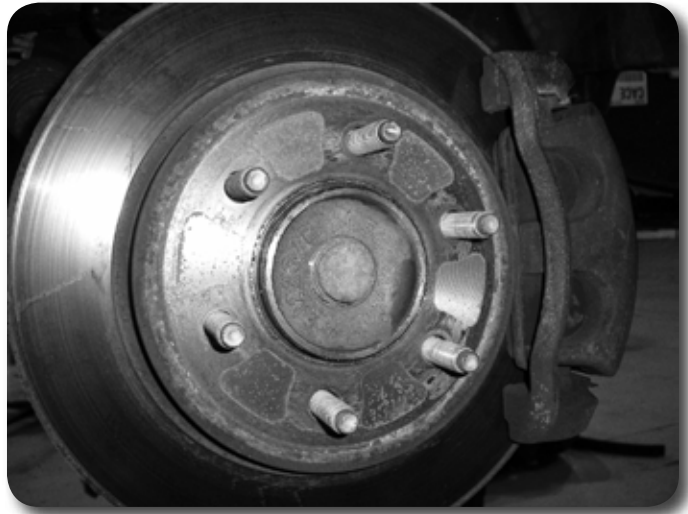

Figure 9

17. Remove the CV axle flange bolts **Figure 10**. Retain bolts, they will be reinstalled later.



Figure 10

18. Loosen but do not remove the three strut assembly mounting nuts at the frame **Figure 11**. Do not loosen the middle strut nut.

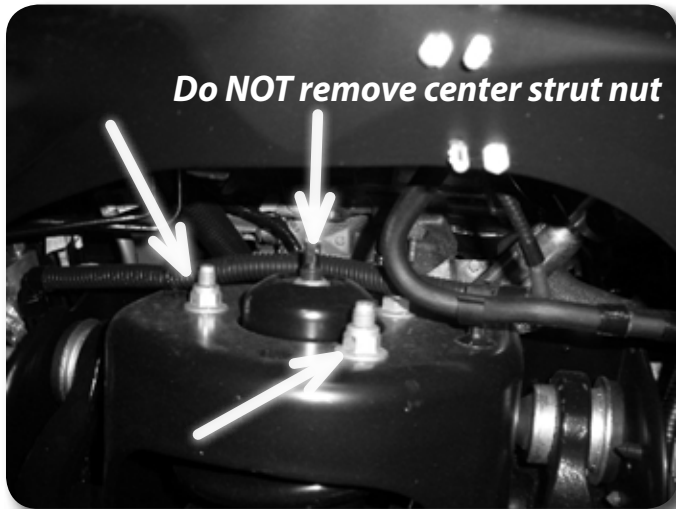

Figure 11

19. Loosen and remove the nut from the strut-to-lower control arm mounting bolt **Figure 12**. Leave the bolt in place at this time. Retain the mounting nut.



Figure 12

20. Remove the upper and lower ball joint nuts and reinstall a few turns.
21. Strike the knuckle near the upper and lower ball joints to dislodge the joints from the knuckle.
22. Remove the upper ball joint and the strut-to-lower control arm bolt. Swing the knuckle/lower control arm down to remove the CV shaft from the hub. Set CV shaft aside. Retain ball joint nut and strut bolt.
23. Remove the lower ball joint nut and remove the knuckle from the vehicle. Retain hardware.
24. Remove the lower control arm mounting bolts and remove the lower control arm from the vehicle. Retain hardware.
25. Mark the struts to distinguish between driver's and passenger's.
26. Remove the three strut assembly mounting nuts at the frame and remove the strut assembly from the vehicle.

27. Remove the four bolts mounting the factory rear crossmember to the frame rails **Figure 13** and remove the crossmember from the vehicle. Retain hardware and discard the crossmember.



Figure 13

28. Mark the relationship between the driveshaft and the input flange on the front differential. Remove the driveshaft mounting bolts and disconnect the driveshaft from the differential **Figure 14**. Allow the driveshaft to rest out of the way. Retain hardware.



Figure 14

29. Support the front differential with an appropriate jack. Disconnect the differential breather hose from the differential housing. Remove the two driver's side and one passenger's side differential mounting bolts **Figure 15, 16** and remove the differential from the vehicle.

Step 29 Note:

To remove the driver's side front bolt, rotate the steering column to give the most clearance and slide the differential all of the way to the passenger's side to give enough room to get the bolt out. It may still be necessary on some trucks to loosen the steering rack to gain enough clearance

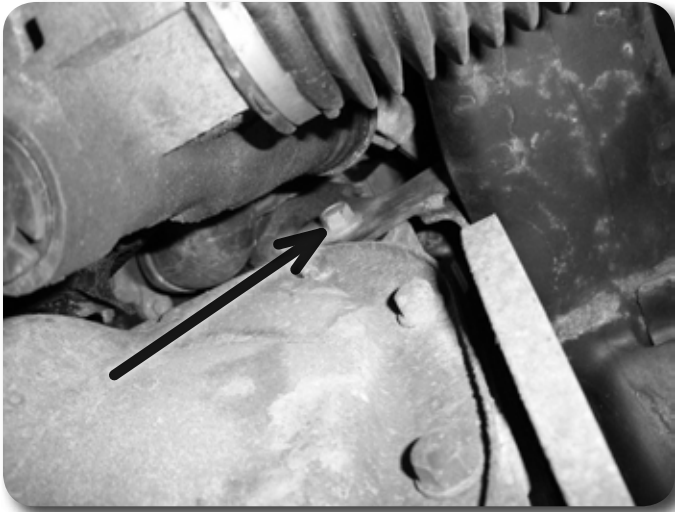

Figure 15

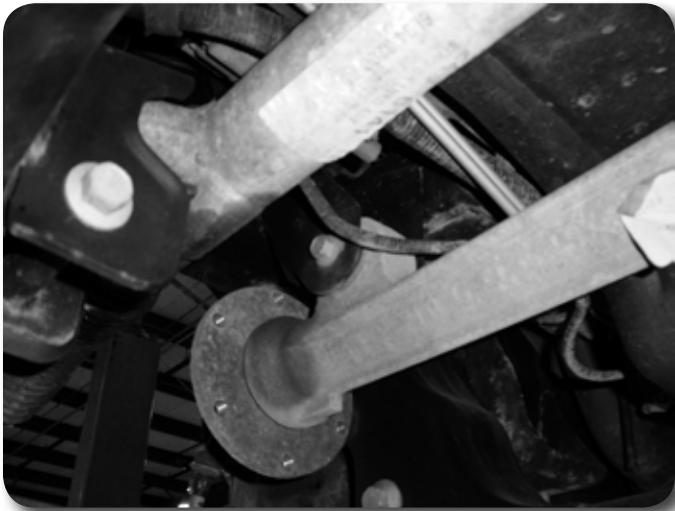

Figure 16

30. Remove the differential breather hose from the connector up near the frame and replace it with the provided longer one.
31. The driver's side rear lower control arm frame pocket must be modified to provide clearance for the differential in its relocated position. On the front side measure from the inside edge of the control arm slot $\frac{3}{4}$ " and mark Figure 17. Make a vertical cut line at the mark.

Step 31 Note

Mark a vertical line $\frac{3}{4}$ " from the inside of the slot

Mark a horizontal line 1- $\frac{3}{4}$ " below the centerline of the slot.

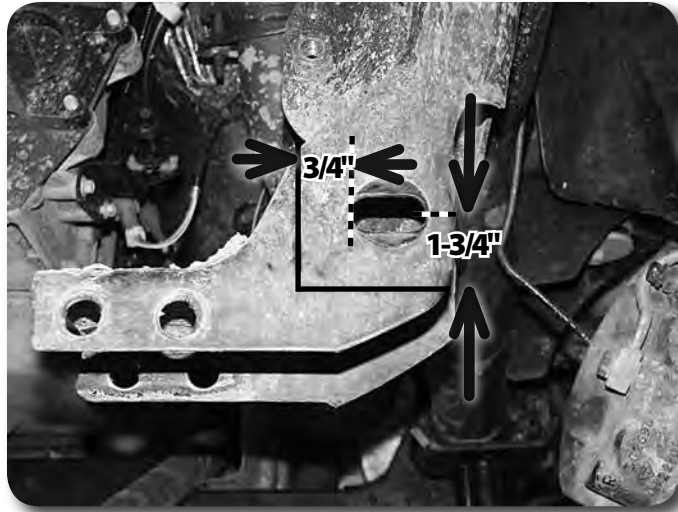

Figure 17

32. Measure down from the center of the slot 1-3/4" and make a horizontal cut line
33. On the back side measure from the inside edge of the control arm slot 1-3/4" and mark Figure 18. Make a vertical cut line at the mark.

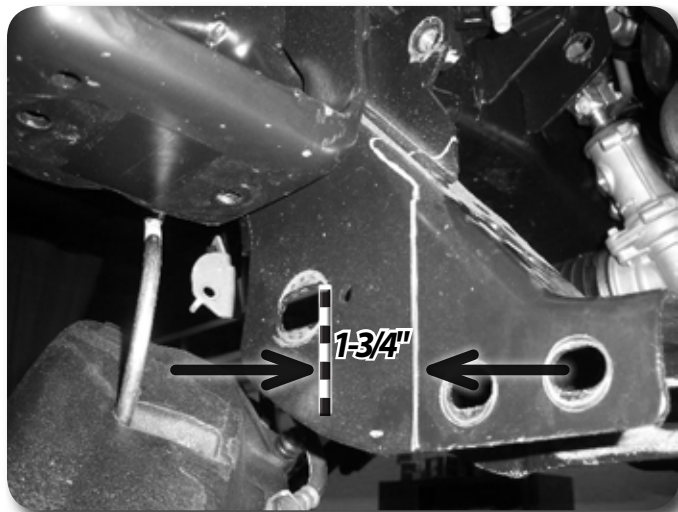

Figure 18

34. Connect the two lines and remove section as shown. Figure 19

Step 34 Note:

On the rear measure over 1-3/4" from the inside of the slot and make a vertical mark.

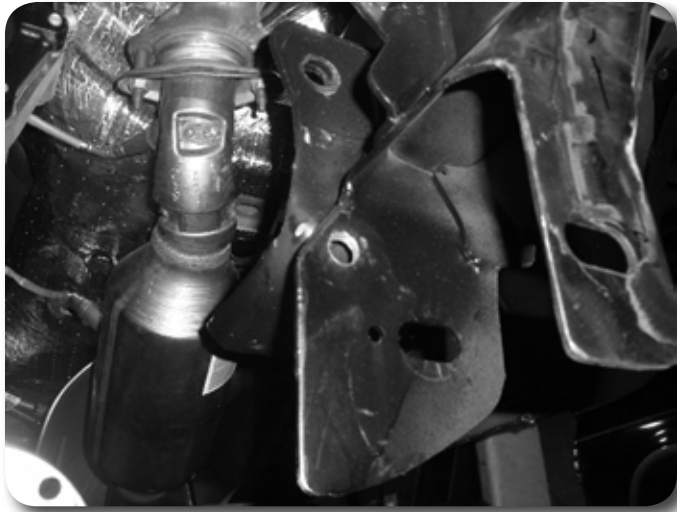

Figure 19

35. On the passenger's side the front must be trimmed to clear the offset bend. Mark from the top of the factory crossmember hole over to the outside edge of the bracket. Trim up to the hole from the bottom. Figure 20



Figure 20

36. Install the rear crossmember with new 18mm bolts. With the crossmember installed, mark the hole for the driver's side rear differential hole. Remove crossmember and drill hole out to 1/2".
37. Install the provided sway bar drop brackets to the original sway bar mounting positions with the OE bolt tab from the top-down. Install the rear crossmember with the provided 18mm bolts and use a 3/4" USS washer as a spacer between the swap bar drop bracket and frame pocket. Run the bolts from rear to front. The open side of the bracket will go to the inside of the vehicle. Place another 3/4" USS washer and 18mm nut on the new rear bolt. Leave hardware loose, it will be removed for reinstalled later in the installation. Ensure the hole that was drilled in the frame pocket lines up to the differential mounting hole in the bracket. Figure 21, 22

Step 36 Note

Trim the passenger's side front from the top of the hole to the outside. Remove section shown in figure.

Step 37 Note

M18 bolts go from rear to front. Each bolt gets 3 washers, 1 is used as a spacer between the sway bar drop and outside of the frame pocket. Sway bar drops use the factory nut tab and hardware.

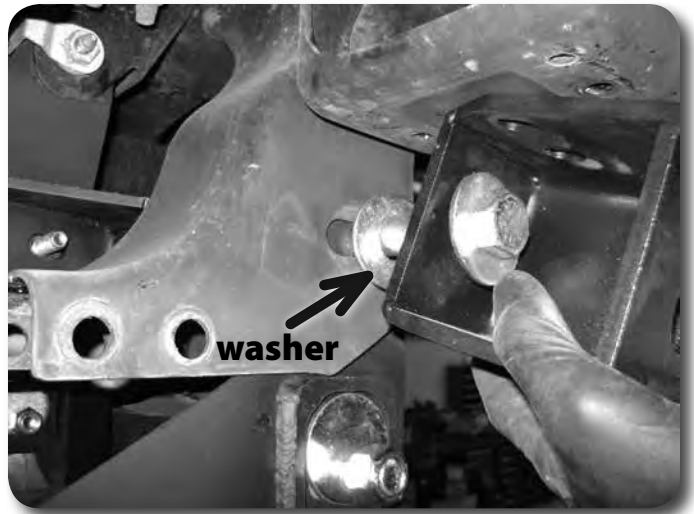

Figure 21

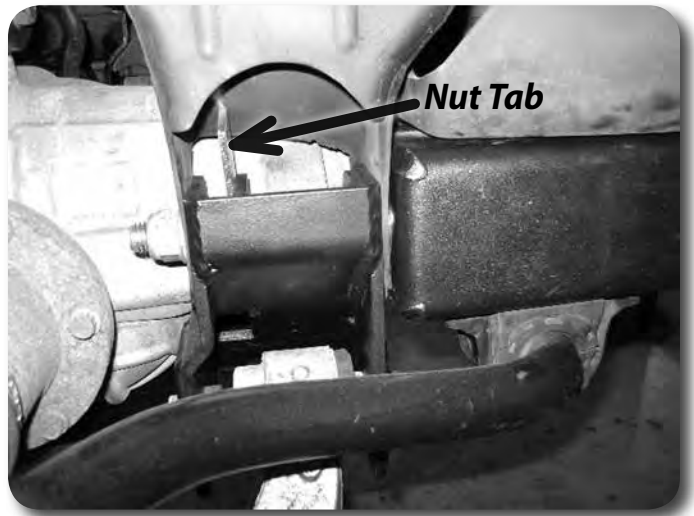

Figure 22

38. Install the new passenger's side differential drop bracket, this bracket has an extra hole on the lower wing [Figure 23](#) and front driver's side factory differential mounting locations with the factory hardware. The brackets should offset toward the front of the vehicle when properly installed. Leave hardware loose.

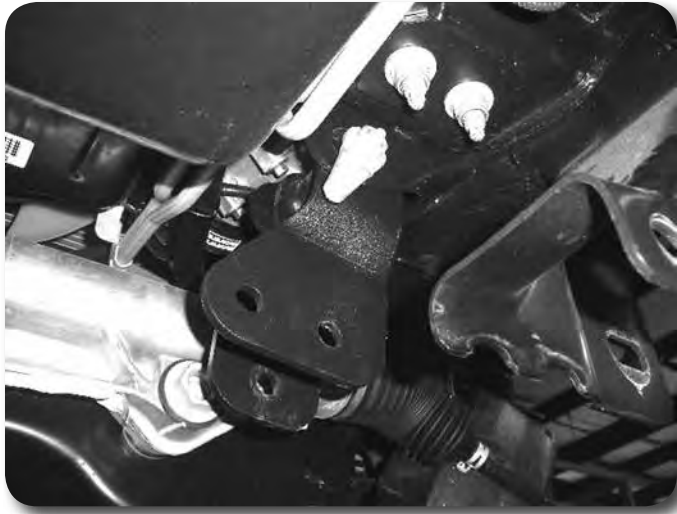

Figure 23

39. Install the differential in the vehicle by aligning the differential mounts in the two front drop brackets and in the rear crossmember. Fasten the differential to the driver's front bracket with a 12mm x 100mm bolt, nut and 12mm washers. Fasten to the passenger's side bracket with a 12mm x 110 bolt, nut and 12mm washers, running from the front to rear. Leave all hardware loose.
40. Fasten the differential to the rear crossmember **Figure 24** with a 7/16" x 3-3/4" allen head bolt in conjunction with the provided nut tab. Leave hardware loose.

Step 39 Note

Differential drop bracket hardware is located in bolt pack # 776



Figure 24

41. Install the provided differential support bracket to the passenger's side differential bracket using the hardware that was just installed and an additional 12mm x 30mm bolt. Attach the other end to the rear crossmember bolt. It is necessary to remove the bolt and reinstall it. Leave hardware loose. **Figure 25 / 26**



Figure 25



Figure 26

42. Go back and torque all the differential mounting hardware to 50 ft-lbs (6 bolts total). Attach the differential breather hose to the differential.
43. Install the front crossmember in the front lower control arm pockets and fasten with the factory lower control arm hardware. Leave hardware loose. **Figure 27**

Step 42 Note

It may be necessary to trim on the flared lip to get the crossmember to fully seat into the pockets.



Figure 27

44. Install the lower control arms in the new crossmembers and fasten with the provided 18mm x 150mm cam bolts, cam washers and 18mm nuts. Run the bolts from rear to front. Center the cams in the slots.
45. Install the provided differential skid plate to the front and rear crossmembers with $\frac{1}{2}$ " x 1-1/4" bolts with Loc-tite and $\frac{1}{2}$ " SAE washers (BP #776) into the weld nuts in the crossmembers **Figure 28** Torque to 65 ft-lbs.

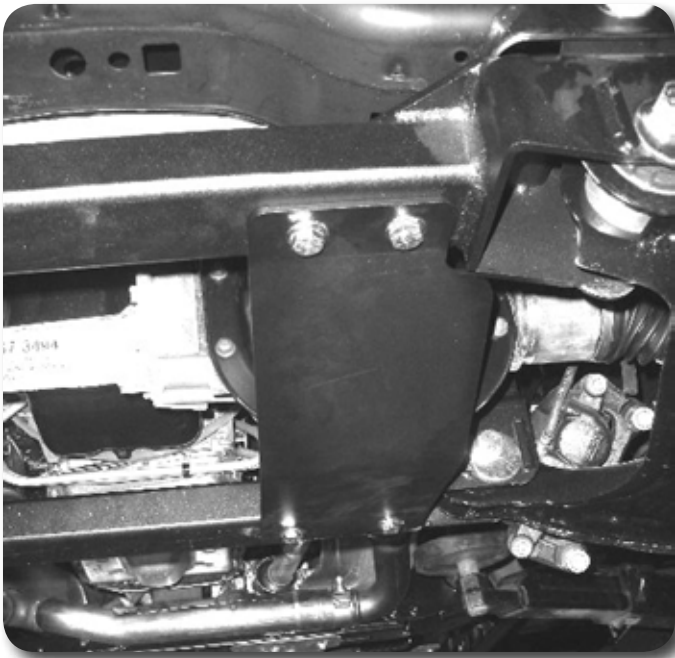

Figure 28

46. Install the provided strut spacers on the struts with the factory nuts. Note: The holes are placed so the spacer will only install one way. Torque nuts to 35 ft-lbs.
47. Install the strut assemblies in the appropriate sides on the vehicle **Figure 29**. The flat side will face 'out' on the vehicle. Fasten the spacers to the factory strut mounts with 10mm nuts and 3/8" USS washers on the welded studs. Leave hardware loose.

Step 45 Note

Differential skidplate hardware is located in bolt pack # 776

Step 47 Note

Strut spacer hardware is located in bolt pack # 629. The flat side of the spacer will face 'out.'



Figure 29

48. Remove the four hub bolts from the knuckle and remove the hub from the knuckle (Figure 30)

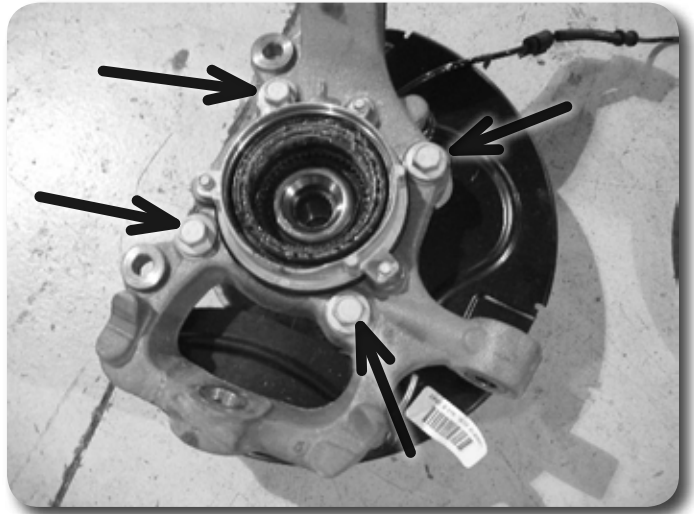

Figure 30

49. Inspect the outer hub assembly mounting surface and clean any dirt or corrosion off as necessary. Install the hub into the corresponding new knuckle and fasten with the factory bolts. Use Loctite on the bolt threads and torque to 148 ft-lbs. Install the ABS wire grommet in the slot in the knuckle.
50. Remove the three bolts mounting the vacuum hub assembly to the factory knuckle and reinstall the assembly in the corresponding new knuckle with the factory hardware. Tighten bolts securely (about 5-7 ft-lbs).
51. Remove the dust shield from the factory knuckle and install on the corresponding new knuckle with the original hardware (Figure 31). Tighten securely.

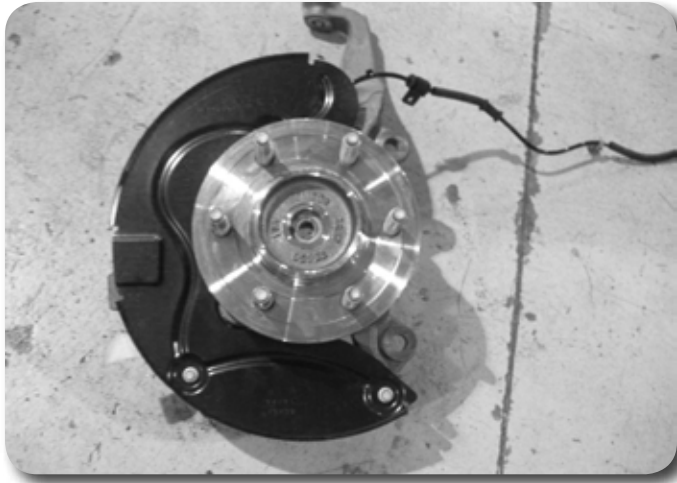

Figure 31

52. Install the new knuckle assembly on the lower control arm ball joint and loosely fasten with the original nut. Install the CV shaft in the hub, swing the whole assembly up and attach the lower control arm to the strut with the original hardware. Leave all hardware loose.
53. Attach the upper control arm to the knuckle with the original nut. Torque the upper ball joint to 85 ft-lbs and the lower ball joint to 111 ft-lbs.
54. Torque the upper strut nuts to 35 ft-lbs. The lower bolt will be tightened later with the weight of the vehicle on the suspension.
55. Fasten the CV shaft to the hub with the original nut and torque to 20 ft-lbs. Reinstall the dust cap.
56. Attach the CV shaft to the differential output flange with the original hardware. Torque bolts to 60 ft-lbs in a crossing pattern.
57. Install tie rod from top-down. Torque to 111 ft-lbs.
58. Disconnect the factory front brake line from the caliper and retain bolt, discard crush washers. Disconnect the brake line from the hard line at the frame and remove the brake line retain clip to free the brake line from the frame bracket. Retain clip and discard the brake line.
59. Install the new brake line to the caliper with the factory banjo bolt and two new crush washers (one on each side of the fitting). The brake lines are driver's and passenger's side specific. The end of the brake line should go up and around the bleeder on the caliper. Torque the banjo bolt to 20 ft-lbs. **Figure 32 / 33**



Figure 32

Step 59 Note

Attach the brakeline to the caliper with factory banjo bolt and new brass crush washers (1 per side). Make sure the 2 old washers are removed before assembly



Figure 33

60. Run the brake hard line through the brake line frame mount and attach the new brake line. Tighten fitting securely.
61. Install the new brake line in the frame bracket and fasten with the new factory style retaining clip.
62. Install the brake rotor and caliper to the knuckle. Fasten the caliper with the factory bolts and torque to 148 ft-lbs.
63. Attach the ABS line to the connector at the inner fender and the vacuum line to the hub. Route the lines (include the brake line) down the back of the knuckle and attach with zip ties at the upper control arm. Attach the ABS wire to the side of the knuckle with the provided wire clip, 6mm x 18mm bolt, and 1/4" washer Figure 34.

Step 63 Note

Attach the ABS wire to the side of the knuckle with M6 bolt and wire clip. Tighten to 10 ft-lbs



Figure 34

64. Torque 10mm sway bar drop hardware to 35 ft-lbs and 18mm front and rear crossmember mount bolts to 222 ft-lbs. Ensure that the front crossmember is centered in the vehicle. Use a socket on an extension to easily access the nuts. Figure 35

Step 64 Note

Sway bar hardware is located in bolt pack #775.

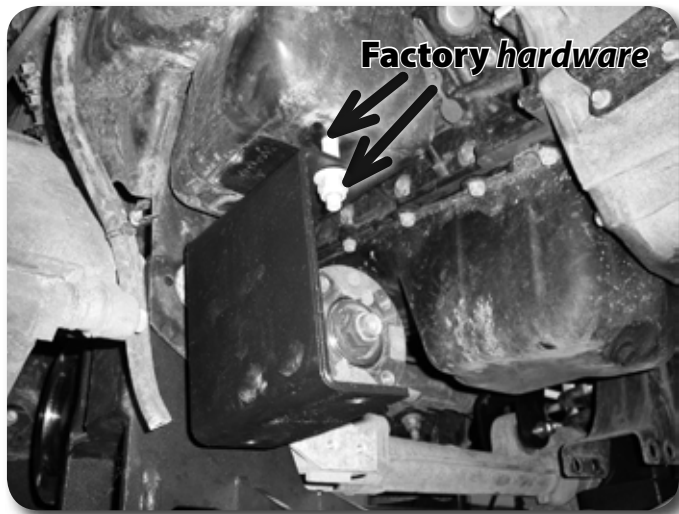

Figure 35

65. Install the sway bar to the new sway bar drop brackets with 7/16" x 1-1/2" bolts, nuts and 7/16" SAE washers. Attach the sway bar to the sway bar end links with the original hardware. Torque the 7/16" hardware to 45 ft-lbs. If the sway bar link is a stem style, tighten hardware until the bushings begin to swell. If the link is a ball joint style, torque nut to 45 ft-lbs.
66. Reattach front driveshaft to differential. Torque bolts to 76 ft-lbs.
67. Install the wheels and lower the vehicle to the ground.
68. Bounce the front of the vehicle to settle the suspension. Torque the lower strut mount bolt to 350 ft-lbs. Center the lower control arm cams and torque to 150 ft-lbs. Tighten upper strut mounting hardware on replacement strut kits to 35 ft-lbs.
69. Bleed brakes starting with the wheel furthest from the master cylinder. See service manual for proper procedure.
70. Check all hardware for proper torque.

» REAR INSTALLATION

71. Block the front wheels and raise the rear of the vehicle. Place jack stands under the frame rails ahead of the spring hangers.
72. Remove the wheels.
73. The parking brake cable must be relocated. To disconnect the cable from the frame first pull down on the cable and clamp it off with vise grips near the middle of the frame **Figure 36**. This will gain slack to disconnect the driver's side rear cable from the main (passenger's side) cable.



Figure 36

74. Remove the driver's side parking brake cable from the junction bracket Figure 37.

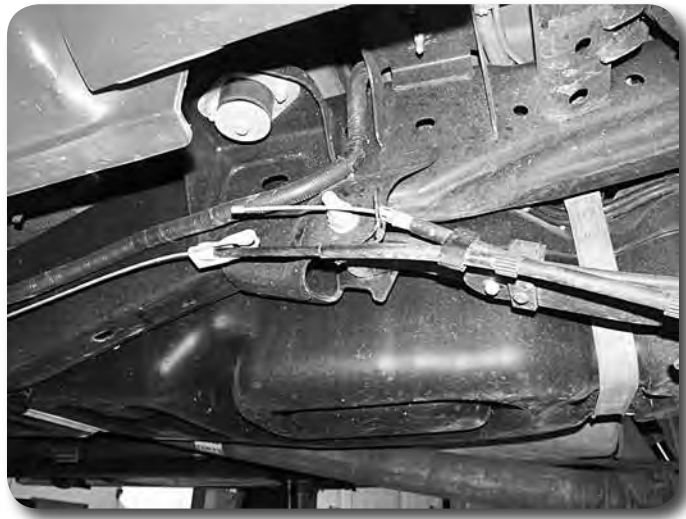

Figure 37

75. Compress the retaining tabs and remove the driver's side cable from the spring hanger Figure 38a. It will be relocated and reconnected later.



Figure 38a

76. Support the rear axle with a hydraulic jack. Remove the shocks. Retain mounting hardware.
77. Disconnect the rear brake line from the frame.

Note: Perform the rear installation on one side at a time.

78. Remove the passenger's side u-bolts.
79. Lower the axle. For 6" kit only, remove the factory lift block, it will not be reused. The factory block will remain in place for the 4" kit.
80. For the 6" kit, install the provided lift block so that the bump stop wing goes toward the inside of the vehicle. For the 4" kit, install the supplied 2" blocks between the factory block and the axle perch.
81. Raise the axle/block to the spring while aligning the center pins. Fasten the spring/block assembly with the provided u-bolts, high nuts and washers. Snug u-bolts, they will be torqued with the weight of the vehicle on the springs.

Repeat installation procedure on the driver's side of the vehicle. Remove the driver's side parking brake cable bracket from the front spring hanger. Remove the front bracket mounting bolt and the nut from the spring bolt and remove the bracket. Retain hardware.

Install the provided parking brake relocation bracket to the driver's side front spring hanger using the spring bolt. The front tab of the bracket should wrap around the front of the hanger and line up with an existing hole. Fasten the bracket with the existing parking brake bracket bolt and the spring hanger bolt. Torque the smaller bolt to 25 ft-lbs **Figure 38b**.

82. Run the parking brake cable through the relocation bracket and reattach to the parking brake cable junction. When reconnected, remove the clamp to allow the cable to return to its normal tension.



Figure 38b

83. Install the provided brake line relocation bracket to the driver's side frame rail with the brake line bracket bolt **Figure 39**. Torque to 15 ft-lbs.
84. Attach the brake line to the relocation bracket with a 1/4" nut and 1/4" USS washer. Torque to 15 ft-lbs.
85. Install the new shocks with the factory hardware. Torque to 60 ft-lbs.

Step 81 Note

In order to install the new rear blocks, it may be necessary to loosen the opposite side u-bolts to allow the axle to be raised and lowered easily.

Step 82 Note

If no hole is present, drill center of one slot to 3/8" and attach with 3/8" x 1-1/4" bolt, washers, and nut. Hardware is provided in bolt pack #775

Step 85 Note

Brakeline relocation hardware is provided in bolt pack #775

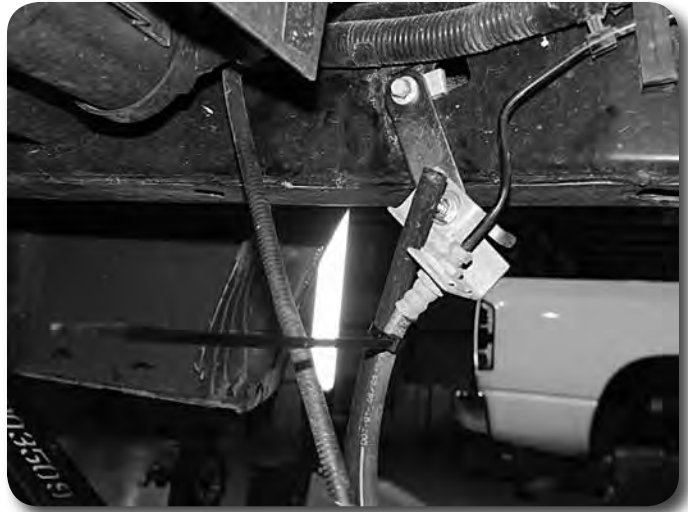

Figure 39

86. Check all lines/wires for proper slack.
87. Install the wheels and lower the vehicle to the ground.
88. Torque the u-bolts to 100-120 ft-lbs.
89. Check all hardware for proper torque
90. Check hardware after 500 miles.
91. A complete front end alignment is necessary.
92. Adjust headlights.

Although unusually rare, if front driveline vibration occurs the front driveshaft must be indexed as shown in the attached figure. The missing spline on the driveshaft must be cut / machined. Use extra caution to not damage the adjacent splines. Thoroughly clean and grease the splines before the driveshaft is reassembled. Reinstall the OE rubber boot with the OE clamp. The driveshaft must be rebalanced before the vehicle is driven.

** Note: After installation is complete and the vehicle is setting on the ground, be sure to inspect the slip on the rear driveshaft. Although highly unusual, certain cab configurations over certain years achieve excessive extension of the rear driveshaft. If this occurs, order rear driveshaft spacer # F5601.*

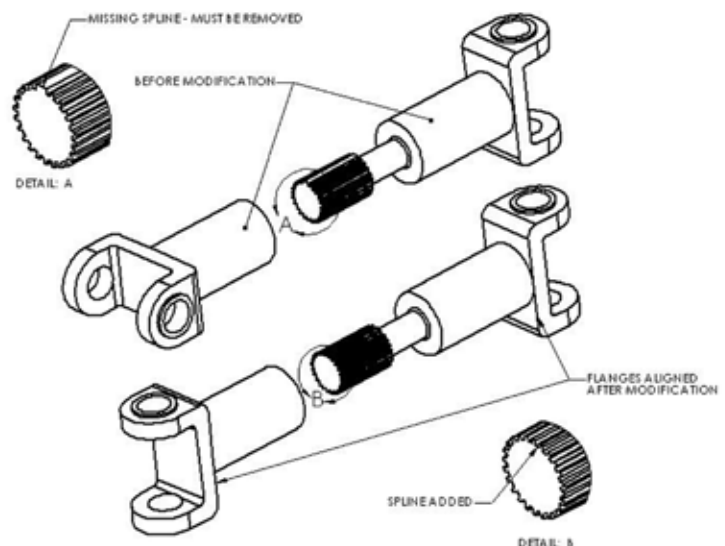

Figure 40