



### Installation Instructions

# 817799

## 2018-20 MUSTANG GT

### 5.0L V8 ENGINE

Fits vehicles with Active Performance Exhaust

#### OVERVIEW:

1. Take a moment to read and understand these instructions before installing your Flowmaster performance system.

**NOTE:** Please inventory all parts now before continuing and if necessary, report any missing items to our tech line. This will avoid potentially stranding your vehicle until any missing replacement parts arrive.

ITM #	PART #	DESCRIPTION	QTY.
1	853063-481	Right Muffler w/ Valve	1
2	853063-482	Left Muffler w/ Valve	1
N/A	PK945	Hardware Package includes:	1
3	MC250BS	2½" Stainless Band Clamp	2
4	HW532	½" OD x ¼" ID x ½" Alum. Spacer	6
5	HW251	¼-20 x 1¼" BHC Screw	6
6	HW332	¼" Split Lock Washer	6
7	HW124	¼-20 Hex Nut	6

#### PREPARE VEHICLE FOR KIT INSTALLATION:

2. Raise vehicle up on a hoist or rack to working height. If you don't have access to a hoist or rack, support vehicle with jack stands.

**WARNING:**

Avoid serious burns! Allow your vehicle time to cool completely before touching any factory engine components.

**To ease preparation and installation of your new kit:**

- Apply penetrating lubricant to mounts, bolts and clamps before you remove them.
- Use stands as necessary to support parts as you detach them from your vehicle and again as you install new parts.

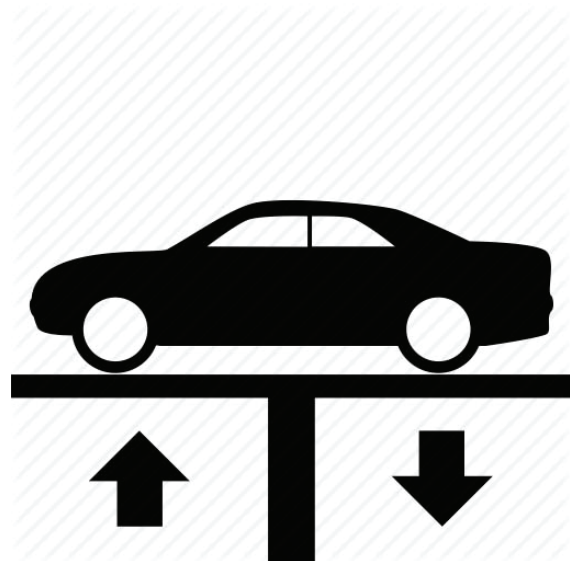

3. For convertible model vehicles, remove body braces. Loosen passenger side brace front bolt then remaining (x8) bolts. Lower brace then repeat process on (x6) driver side bolts.

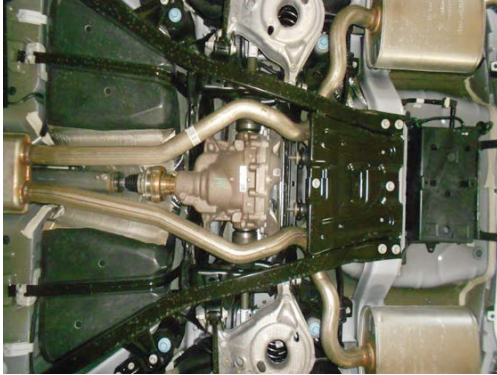

4. For vehicles equipped with heat shields; remove them by cutting through their rear straps, then lift and lower them a few times to break remaining weld.

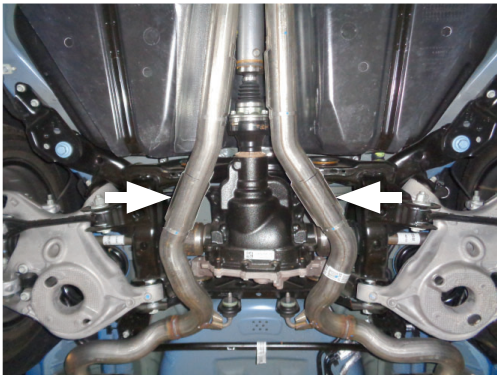

5. Mark each pipe just behind second bend (where bend straightens out). Then, at rear of each muffler, unplug wire to actuator and tuck connection away until later.

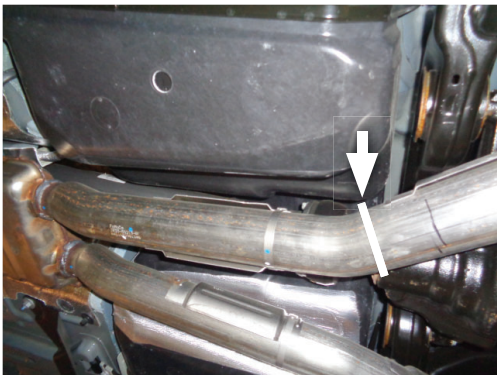

**NOTE:** Use caution as you cut pipes to avoid cutting other engine components.

6. Double check measurements, then cut pipes 5" rearward of marks made in previous step.



7. Unbolt hangers (x2) behind rear differential from cross member. Slide muffler assemblies forward and out of hanger mounts, leaving front hangers attached. Deburr pipe ends then index and remove hanger mounts (x2).



## INSTALL FLOWMASTER EXHAUST SYSTEM

8. Transfer hanger mounts over from stock to new mufflers. Remove nuts from stock and Flowmaster clamps, apply anti-seize compound to bolts and re-install nuts.

**NOTE:** The image in this step is intended for illustrative purposes only and may or may not accurately reflect components included in your kit.

9. Both mufflers must seat approximately 2½" deep. Mark them accordingly so they fit properly onto your vehicle.



**NOTE:** Before completing this step, carefully index the exact placement and location of wire loom bracket on both left and right valves so that you can re-install them identically in step 13.

10. Remove nuts (x3) securing exhaust valve actuator to exhaust valve. Retain nuts and wire loom bracket for later use.

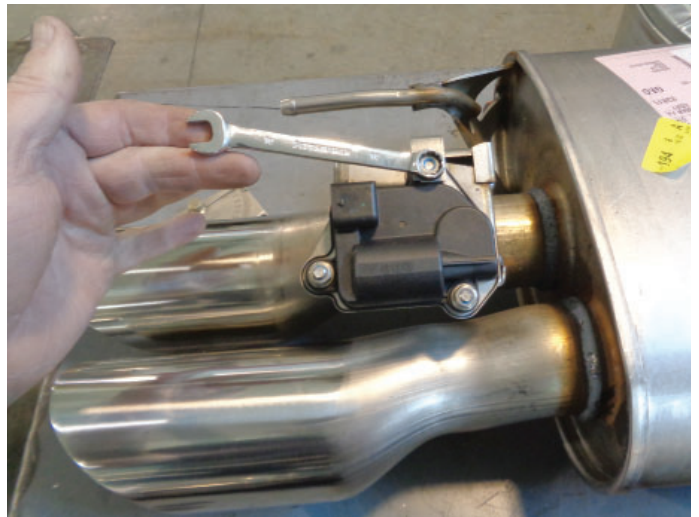

11. Lift actuator with heatshield and spring attached from factory valve assembly.



12. Install actuator onto valve by lining spring arm to valve shaft notch then lower it into place. Rotate actuator assembly holes to line up with mount holes.

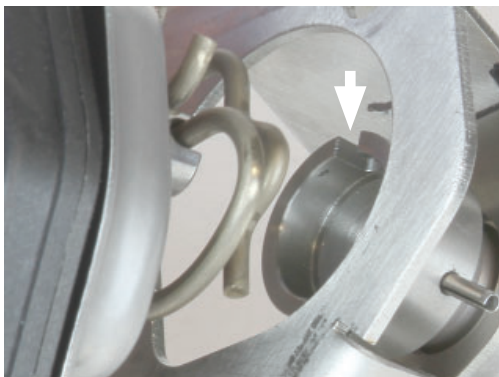

13. Place each wire loom bracket onto left and right actuator (as indexed from step 10) then fasten assemblies exactly as shown (x3 ea.) **screws (5)**, **spacers (4)**, **split lock washers (6)** and **hex nuts (7)**.

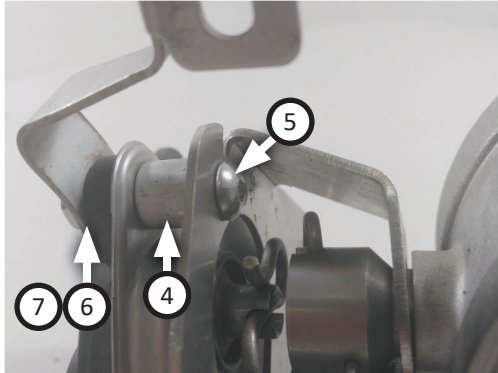

14. Place **clamp (3)** onto **right muffler (1)** then connect it to passenger side factory pipe. Support assembly, re-install rear hanger mount to frame then re-install front hanger to cross member.

15. Repeat step 14 with **left muffler (2)** on driver side of vehicle.

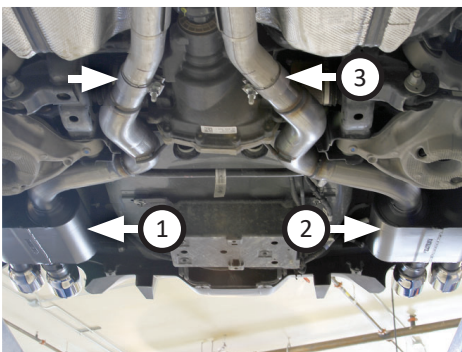

16. For convertible model vehicles, re-install body braces.  
17. Adjust and level mufflers fit, centering tips in bumper cut-outs. Maintain 1/2" clearance and compensate for suspension, travel and vibration then tighten all clamps.  
18. Recommended: Secure slip-fit connections with a 1-inch tack weld then spray high-temp paint over each weld to prevent rust and premature corrosion.

Congratulations, the installation of your FLOWMASTER performance exhaust system is now complete!





Installation Diagram

**817799**

**2018-20 MUSTANG GT**

**5.0L V8 ENGINE**

Fits vehicles with Active Performance Exhaust

